

AgieCharmilles

CUT E 350

CUT E 600



GF Machining Solutions: all about you

When all you need is everything, it's good to know that there is one company that you can count on to deliver complete solutions and services. From world-class electrical discharge machines (EDM), Laser texturing and Additive Manufacturing through to first-class Milling and Spindles, Tooling, Automation and software systems — all backed by unrivalled customer service and support — we, through our AgieCharmilles, Mikron, Liechti, Step-Tec and System 3R technologies, help you raise your game and increase your competitive edge.

Swiss design and quality

Contents

Key points	4
Intelligence inside	6
Machine concept	8
Swiss quality	10
Numerical control and interface	12
Digital IPG generator	14
Machine performance	18
Machine options	19
Customer Services	20
Certified wires	21
Technical Data	22
GF Machining Solutions	26



Experience flexible, intelligent job management, speed-dedicated processes

The CUT E 350/CUT E 600 range puts efficiency at the touch of your finger with a smart, easy-to-use human-machine interface (HMI) and onboard technologies that streamline your job setup, improve your cutting speed, improve your surface finish, protect your valuable workpieces, and ensure your process robustness.

Key points

Touch your success

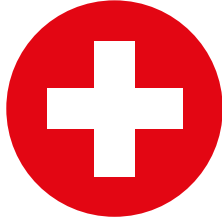

Swiss innovation keeps you ahead

Swiss tradition for constant innovation and strict quality standard push back the boundaries.

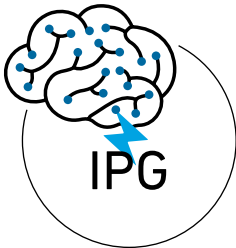

Power your performance

Your business performance is powered by machine performance. Our Intelligent Power Generator (IPG) boasts a wide range of expert technologies helping you to achieve the surface quality and precision your discerning customers demand.

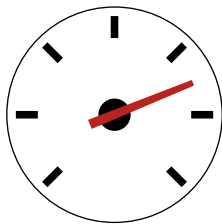

Accelerate your productivity

Time saved is money earned. Onboard speed technology package puts you on the fast track to provide excellent performance at an affordable price.



Experience ergonomy

You're just one click away from machining perfect punches, dies, molds and parts, thanks to our intelligent, intuitive AC CUT HMI. Included are powerful tools for fast, safe machining preparation to make your machine programmer's life easier. Industry 4.0 at the tip of your finger.



Benefit from our expertise

You benefit from GF Machining Solutions' legacy of more than 60 years of EDM expertise. We attach extreme importance to our ability to provide you highly competent application support, Customer Services and business support for your specific field.



Intelligence inside

Expert solutions for your success

You benefit from GF Machining Solutions' legacy of more than 60 years of EDM expertise. That expertise informs our solutions and triggers your success.

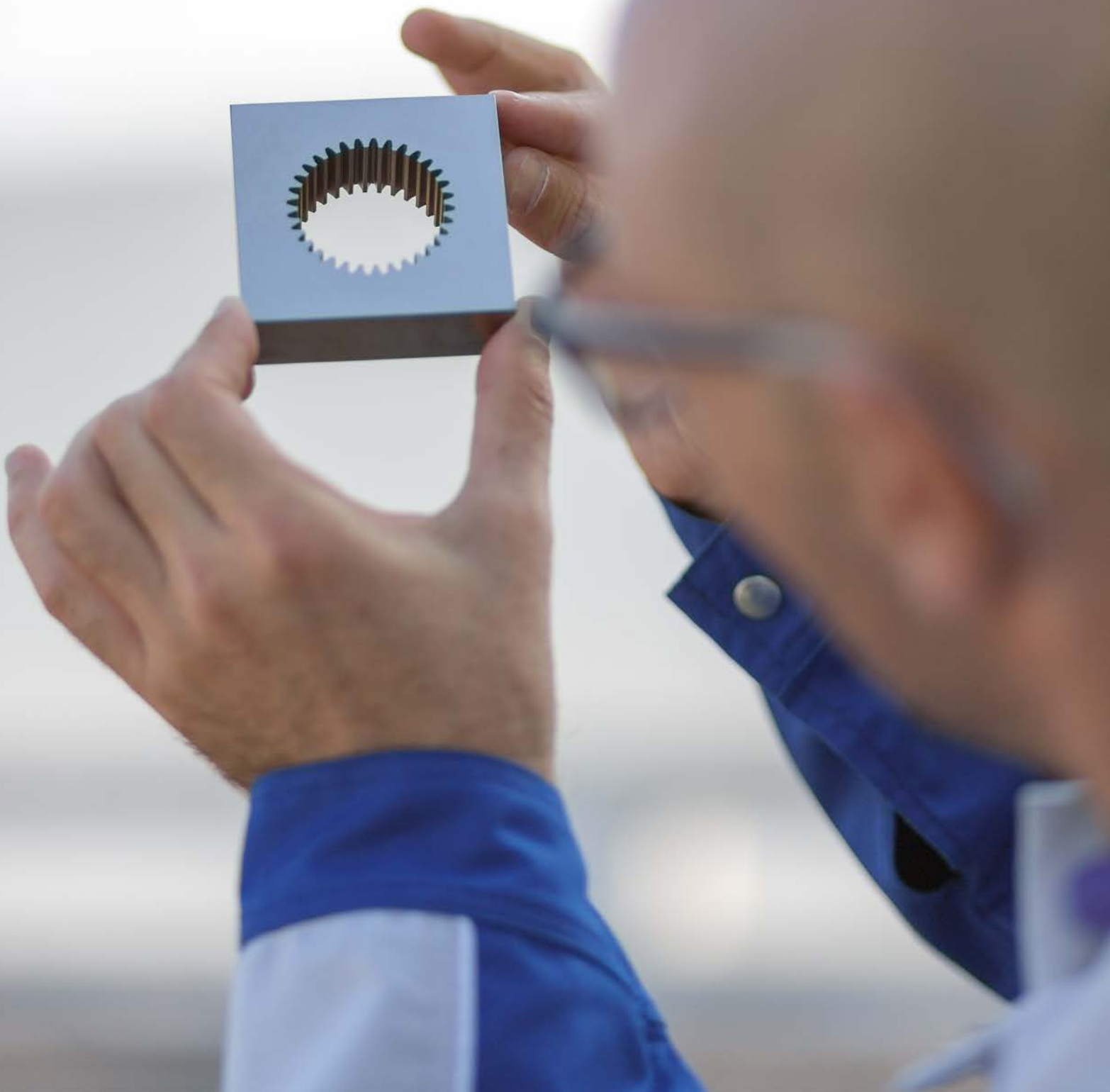

PART EXPRESS

Operators sometimes face unexpected situations. It is very common to be confronted with a change in priorities in the flow of production. With AC CUT HMI, the insertion of an urgent machining job can be done in a simple, rapid and reliable manner and you can resume the previous work exactly where it was interrupted.

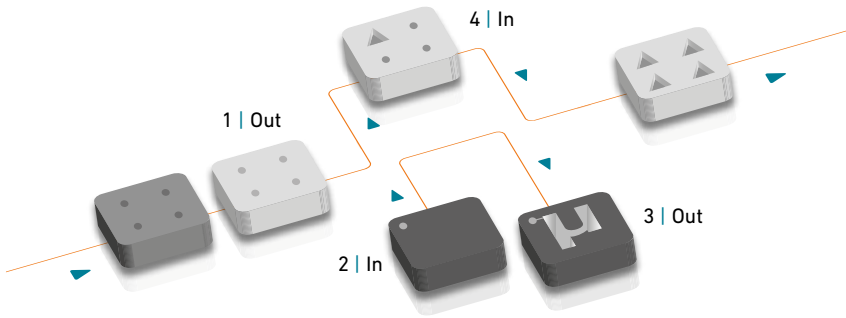

AUTO RESTART

If the power goes out, the point and the job name are memorized, allowing a direct re-start of the job after power is restored.

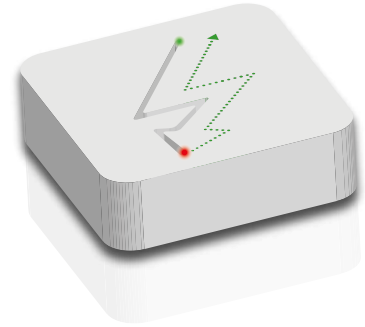

POWER-EXPERT

Wire breakage prevention on parts with variable heights

This smart module continually analyzes the machining conditions and adapts the power according to the geometry modifications. Critical situations such as when the part is approaching or crossing a blind hole, are fully automatically controlled by POWER-EXPERT.

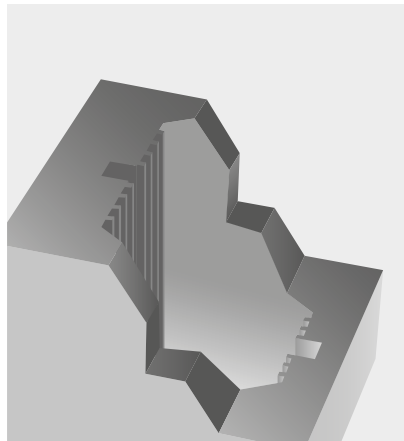

Integrated Collision Protection (ICP) saves you money

Your operator can work with greater confidence during job preparation and execution, because the ICP on the X, Y and Z axes protects sensitive workpieces from damage.



TAPER-EXPERT

Mastery of large tapers

TAPER-EXPERT allows very precise machining of taper with angle varying from 0 to 30°. Thanks to a dedicated measuring cycle, the position of the guides will be defined accurately according to the angle. During machining, the position of the wire will be corrected automatically according to this measuring cycle result. Despite angles up to 30°, the surface quality is close to cylindrical machining.

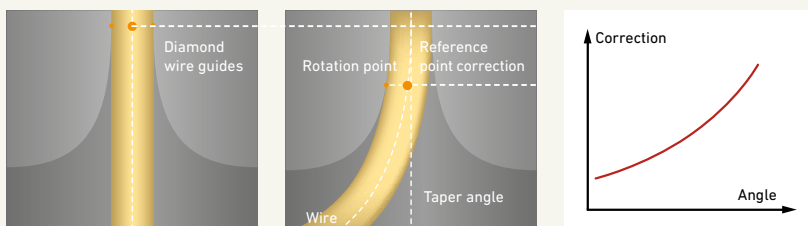

WIRE-EXPERT

Precision over height

Control of the conicity of the piece compensates for the wire wearing across the height.

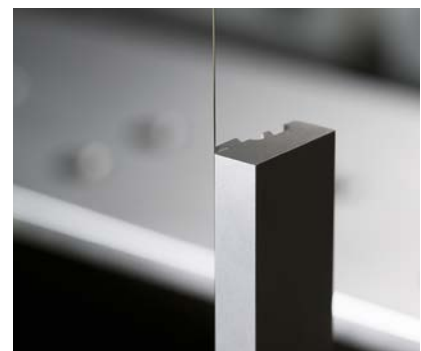



Filters
For easy operation. We positioned the two filters side by side to make maintenance fast and easy.

Uses 30 percent less floor space compare to previous model

Compact layout

For space savings. The compact layout of about four square meters allows efficient integration of the CUT E series into your workshop.

Drop door

For best use of workshop space. The standard drop door system allows easy and convenient access to the working zone.

Machine concept

New design, new features based on years of legacy

Solutions to advance your performance and productivity, secure your processes, and accelerate your time to market are engineered into the CUT E 350/CUT E 600 wire-cutting EDM machines

Thermocut for easy operation

Your key to successful, efficient threading is preparing the wire properly before threading, thanks to the Thermocut module.

Wire circuit

Reliable table wire circuit design ensures a perfect unrolling process that does not disrupt the EDM process during machining.

Automatic threading

The automatic threading and rethreading is rapid and useful for all kinds of coated and uncoated and hard and soft brass wires.



Automatic indexing chuck

Autoindexer is an integrated rotary indexing unit with continuous 90° capability intended for submerged use in wire EDM machines.



Remote control

Designed for one-handed use, the remote control is a standard feature offering ease of use and help in fine tuning workpiece preparation.

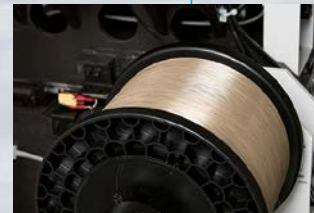

Large spool

A 25 kg spool option is available for both the CUT E 350 and the CUT E 600 to extend running hours and allow continuous production in combination with
- 20-liter deionizing bottle
- Two filter cartridges

Save energy: an economic and ecological necessity

In order to control production costs, saving energy has become a priority in many workshops. The Econowatt modules manage the electrical power of the machine so as to never waste energy when the machine is running unattended. When machining is finished or interrupted, the power supply is reduced to the minimum, lower than 1 kW, or completely disconnected depending on the parameters of the machine. Automatic restart is programmed according to a daily schedule corresponding to the working hours of the workshop. The machine is switched on in sufficient time to be thermostabilized when the workshop opens.

Swiss quality

Engineered for precision and repeatability

The CUT E series is designed to make it easy for you to accurately machine even large, heavy workpieces. You can count on highly repeatable results.

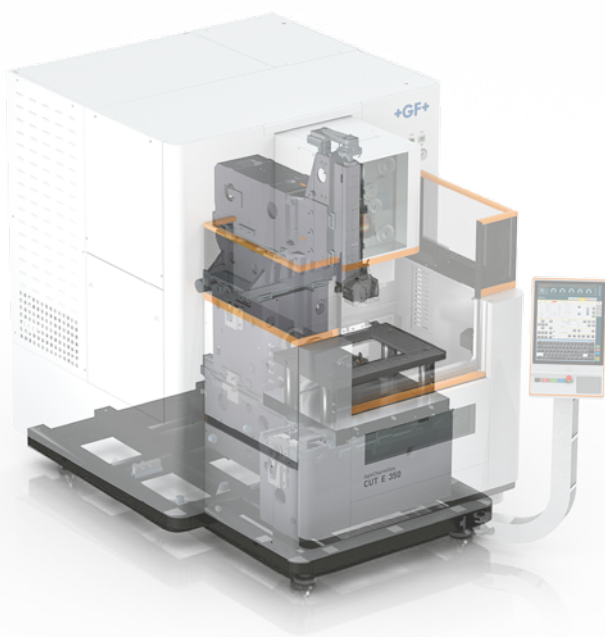

T shape

For accuracy. The T-shaped based frame permits loading of large and heavy work pieces. The compactness and independence of the XY/UV axes guarantee good positioning accuracy and highly repeatable results.

Large/heavy workpieces

Thanks to the standard drop door, large and heavy workpieces up to 1,000 kg can be easily loaded and unloaded.

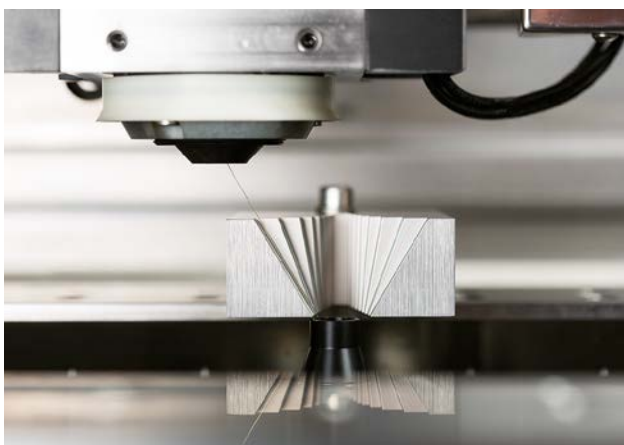

Taper

Precision cuts up to 30° over 77 mm are enabled by a compact and flexible mechanical concept.



Glass scales

For repeatability. The glass scales preserve long-term accuracy, require no recalibration, and eliminate classical screw system errors related to backlash and wear.

Numerical control and interface

A new era of functionalities with an ergonomic HMI

With a 19-inch touch screen with pinch-and-pull effect for high detail accuracy, intuitive logic for fast learning, and a new hand box designed for one-hand use, the AC CUT HMI makes fast work of programming multi-cavity and multi-technology jobs.

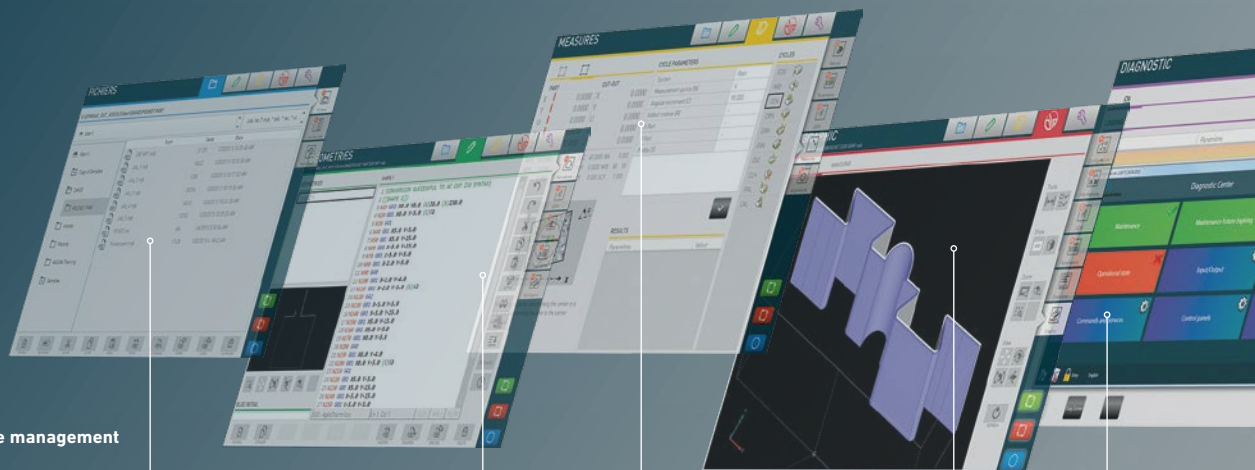

File management

Manage folders and files, create a new job folder, send an existing job to **preparation** or **execution** modes

You can easily organize the execution of a succession of jobs, get the status of each job executed, and create and store job reports

Get autonomy by access to AC CAM EASY programming system

Programming

Allows import or creation of geometries to be cut

Defines machining conditions and sequences with our EDM EXPERT function

Organizes the succession of operations

Offers tables to store variables and points

Allows 3D graphic preview of the job execution

Execution and monitoring

Configure & follow-up the execution of a job

Provides a job execution cockpit

Displays current job's variables and points

Allows optional block management, wire threading and cut configuration

Displays current job's operations that allows monitoring graphically the execution progress

Manual mode setup

Directly access the main machine functions, perform manual measurements, run manual movements, and perform manual machining

Offers tables to store variables and points and displays machine variables

Select, modify and load generator setting for manual machining

Gives a feedback about machining conditions

Offers numerous measuring cycles to allow part reference pick-up

Configuration and maintenance

Manages wire, deionization resins and filters consumption

Allows user to set preferences and adjust user's profile

Allows setting and calibrating machine functions, taking axis references

Displays the current configuration of the system

Allows to set and activate e-connection functions



Area which provides relevant information about consumables, job execution and messages

Area that allows programming, execution and monitoring of the fields

Operator's panel and keyboard for manual data input (MDI)

19-inch touch screen
The 19-inch touch screen gives you a clear view of the process management. Job preparation, monitoring of the current job, and various function are available in a single view.



Digital IPG generator

Power your performance

Your efficient production is at the heart of the modern IPG. Its onboard technologies boost cutting speed, precision and surface quality to satisfy your customers and put you ahead of your competitors.

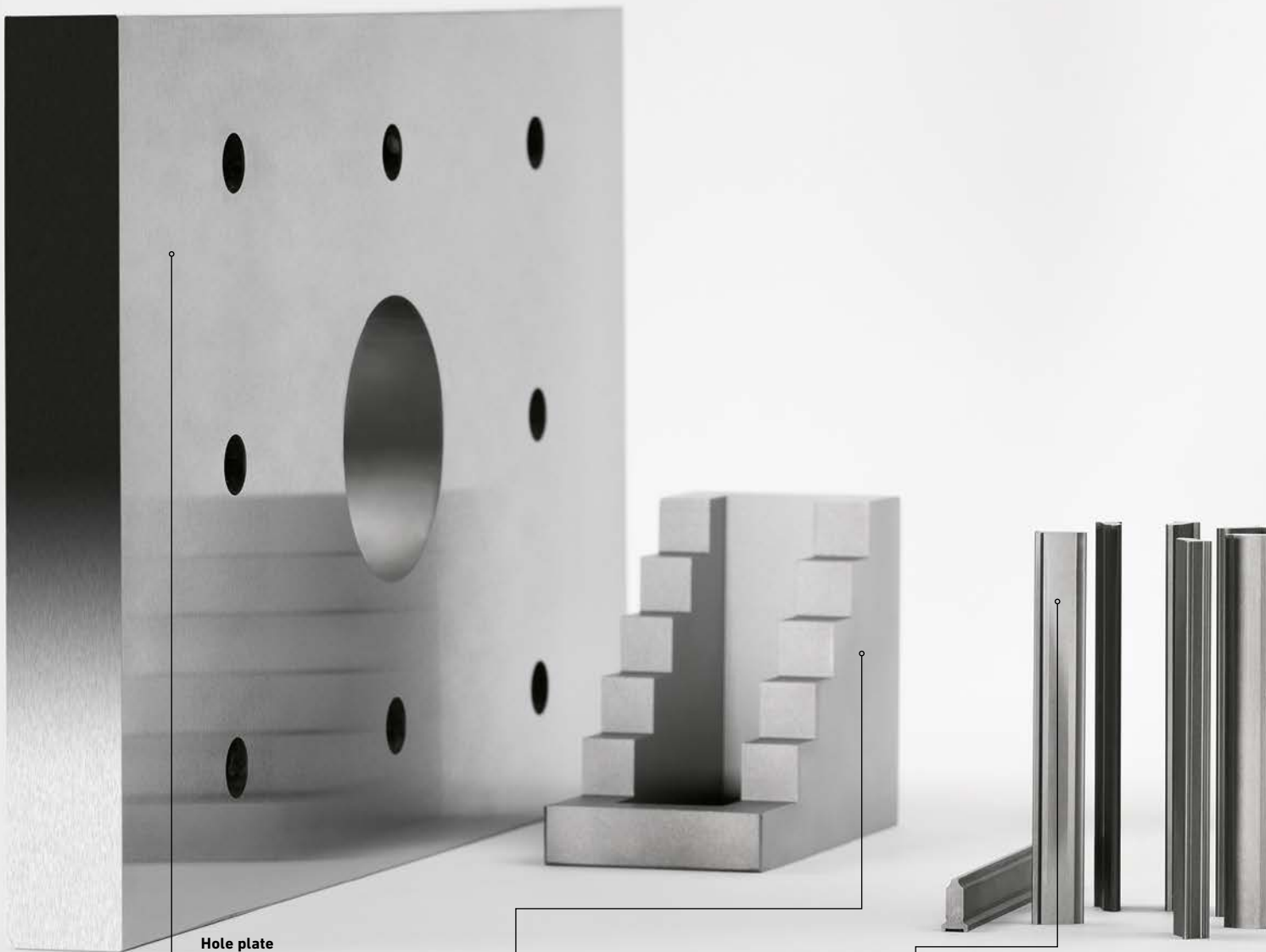

Hole plate

- Dimensions: 250 x 150 x 15 mm
- Steel
- AC CUT AH (brass coated) wire
- Five cuts
- Positioning accuracy: $\pm 3 \mu\text{m}$
- Surface roughness: Ra 0.22 μm

Variable height

The POWER-EXPERT module decides the optimal power to send in the wire, and is especially efficient for stepped parts.

- Height: 10-60 mm
- Steel
- AC Brass 900 (hard) wire
- Three cuts
- Surface roughness: Ra 0.55 μm

Stamping punch

The corner strategy module automatically adjusts the parameters during changes of direction to ensure sharp angles and small radii.

- Height: 60 mm
- Steel
- AC CUT AH (brass coated) wire
- Five cuts
- Contour accuracy: $\pm 5 \mu\text{m}$



Form accuracy

- Height: 60 mm
- Steel
- AC CUT AH (brass coated) wire
- Five cuts
- Maximum dimensional error TKM: $\pm 2 \mu\text{m}$

High part

- Height: 150 mm
- Steel
- AC CUT AH (brass coated) wire
- Six cuts
- Maximum dimensional error TKM: $\pm 5 \mu\text{m}$

Hard metal die

- Height: 20 mm
- Tungsten carbide
- AC CUT AH (brass coated) wire
- Five cuts
- Surface roughness: Ra 0.17 μm

Stamping die

- Height: 20 mm
- Steel
- AC CUT AH (brass coated)
- Five cuts
- Clearance: 4 μm
- Surface finish: Ra 0.22 μm

Taper

The CUT E series demonstrates its versatility by offering the capability to cut cones

- Up to 30 degrees over 77 mm height
- Steel
- AC Brass 400 (soft) wire
- 5 cuts
- Surface roughness: Ra 0.55 μm

Digital IPG generator

Dedicated to accelerate your productivity

Our latest anti-electrolysis IPG generator combined renewed state of the art CNC control is the new base for the next generation GF Machining Solutions machines. The future is here.



Electronic integration

The latest generation of GF Machining Solutions' power generators allows a digital control of each spark allowing precision and very fine surface quality down to Ra 0.16 μm .



Easy EDM management

EDM EXPERT module generates the best process according to precision and material needs. A large panel of preconfigured technological parameters enables an optimal choice of parameters for your application. Combined with the latest state of the art GF Machining Solutions wires enables excellent performances.

Steel dedicated process range

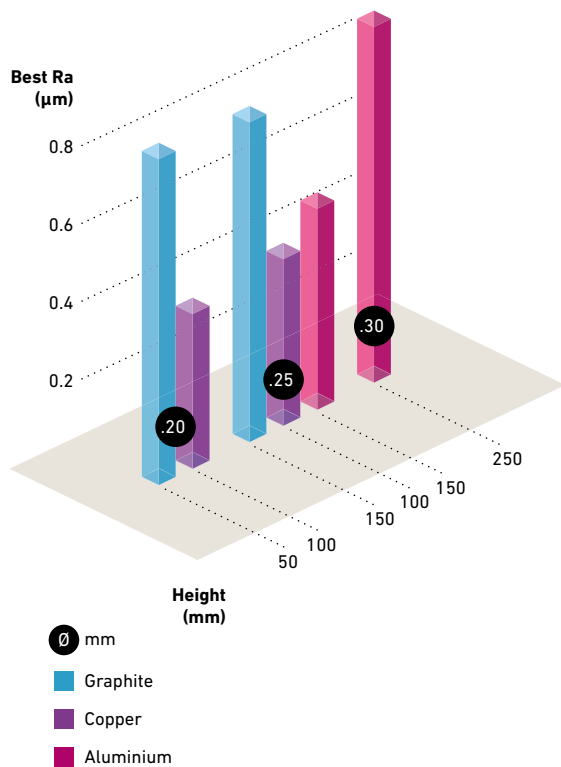
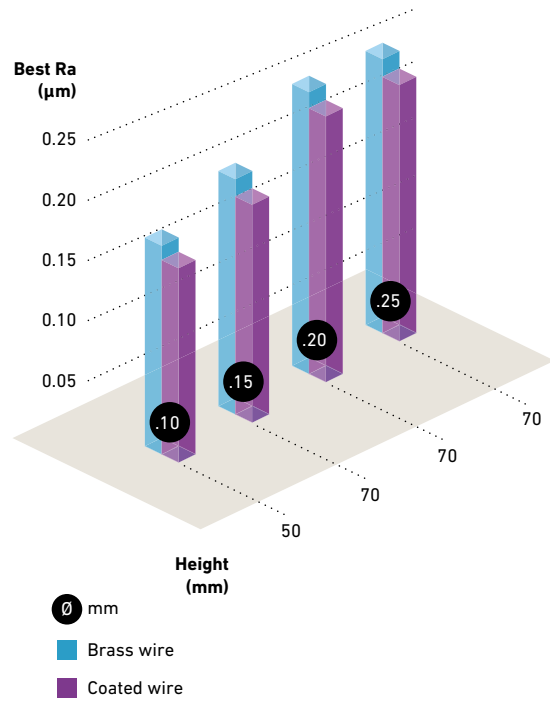
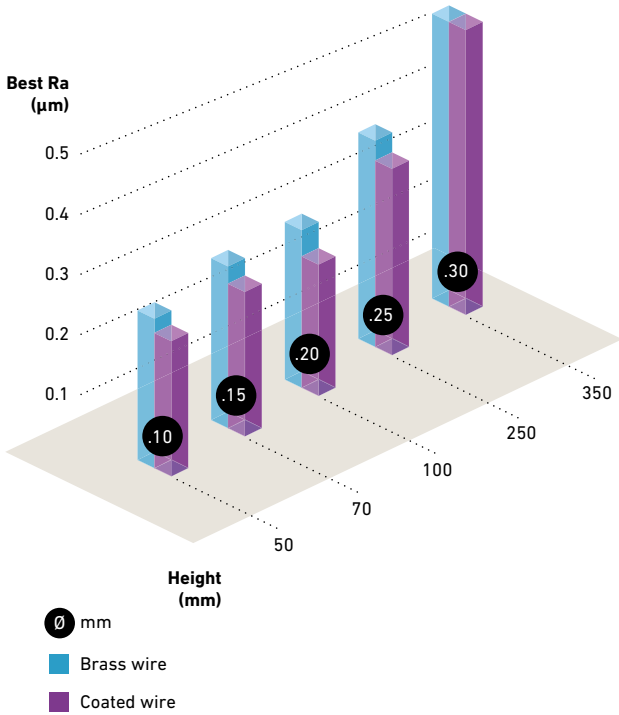

Speed dedicated process

Focusing on productivity, the integrated processes are saving you time and can reduce cutting time by as much as 18 percent compared to equivalent standard machines.

AC CUT VS

A wire EDM machine has a very wide range of applications and the choice of wire is crucial in order to obtain the best productivity and optimum results in terms of speed, precision and surface finish. The GF Machining Solutions AC CUT VS certified wire accelerates cutting speed that allows to increase machining speed up to 15%.

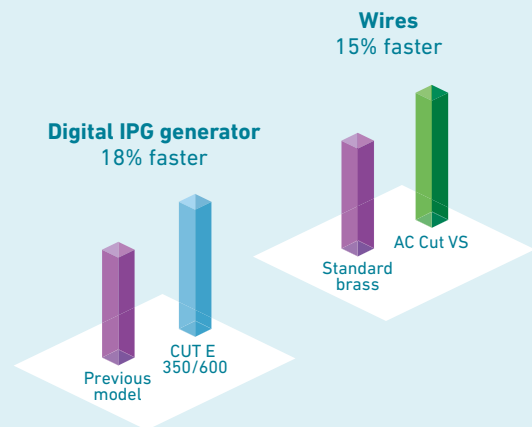

Machine performance

Outstanding precision and repeatability

This part was machined under the conditions our customers face daily in the stamping industry. It demonstrates the excellent machining capabilities essential for precision parts: remarkable form accuracy, excellent contour precision, exemplary surface quality and outstanding production repeatability—four reasons to buy a CUT E series machine.

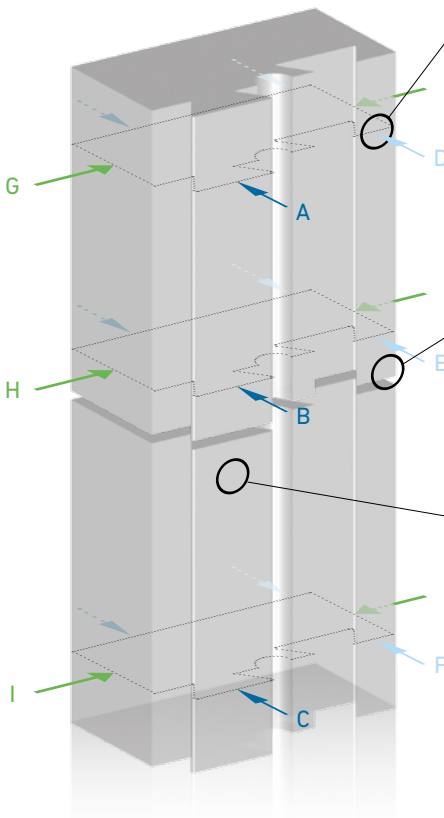
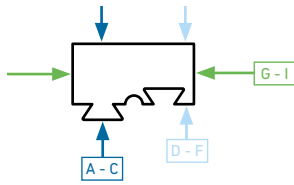

TKM

Maximal error (e) calculated by subtracting highest from lowest deviations compared to nominal on dimensional measures A to I.

$$TKM = \frac{\text{Max}(e_{A-I}) - \text{Min}(e_{A-I})}{2} = \pm 2 \mu\text{m}$$



Contour accuracy

± 5 μm maximal deviation measured on contour at three heights. Shows imperfections on angles.

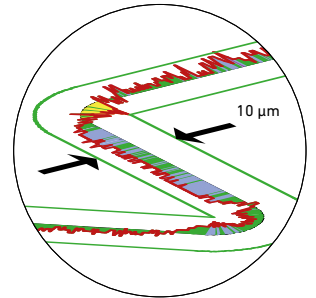

Geometrical accuracy

Parallelism

//	2.5 μm	Z
----	--------	---

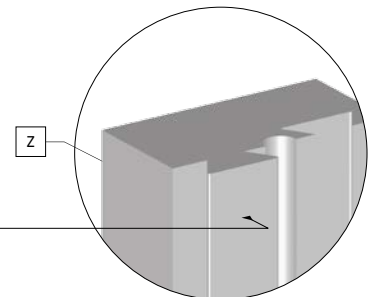

Corner strategy

The corner strategies adjust automatically the machining parameters during changes of direction. Even on the smallest details, high geometrical accuracy is obtained.

To ensure accuracy of:

- Sharp angles
- Small radii

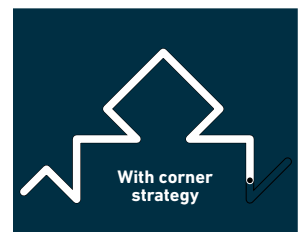
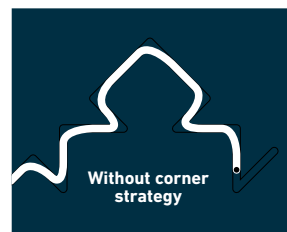

Machine options

Customize your solution

Make your CUT E 350/CUT E 600 solution distinctly yours by customizing it to your specific workshop needs. It's as easy as choosing from our wide range of options.



Set of wire guides

Set of two closed wire guides in diamond with clearance.
- Available diameters:
0.1, 0.15, 0.2, 0.25, 0.3 mm



Kit for wire diameter 0.100 mm

This set includes all the parts that ensure a good machining reliability when using a wire diameter of 0.1 mm.



Alarm lamp

Stack lamp for the visualization of the equipment status
- Stack three-light unit (green, yellow, red)
- Mounting material



18 kVA external transformer



Additional year parts warranty

This is an extension of the first year warranty. The contract is on the same legal basis as applicable to the first year warranty for the parts only. Consumables and wear parts are excluded. This option must be purchased when the machine is ordered.

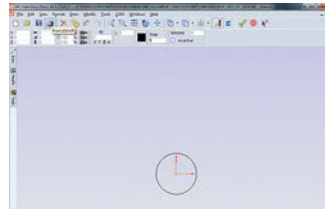

AC CAM EASY

Professional license

This option is the updated package from the basic version to professional version.



Taper kit

Option for accurate taper cutting
- One set of large radius guides
- One threading nozzle
- One set of nuts
Available for 0.2 and 0.25 mm diameter wires.

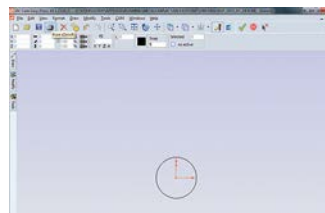

AC CAM EASY

Advanced license

This option is the updated package from the basic version to advanced version.



Automatic indexing chuck

Autoindexer is an integrated rotary indexing unit with continuous 90° capability intended for submerged use in wire EDM machines.



Large wire spools up to 25 kg for more running hours

Customer Services

Solutions for you

More value

Equipment availability, productivity and continuous improvement are essential drivers for your business. Therefore your service strategy today is a crucial success factor. GF Machining Solutions Customer Services offers you a modular concept with three levels of support. You choose the services that fit best to your specific needs.



Maintenance program: to minimize maintenance costs and optimize productivity

Our qualified service experts will visit you on a regular basis to examine and adjust your equipment and, when necessary, exchange maintenance parts.

Regular maintenance is the first step to ensuring the full productivity potential of your GF Machining Solutions machine fleet. Armed with detailed, customer-centric checklists, we use state-of-the-art measurement tools to painstakingly inspect and adjust your machines.

Many years of maintenance experience for EDM machines are consolidated in our checklists. Every visit ends with a machining test in order to confirm the successful and satisfying completion of our services.

Maintenance every
2,000 machining hours* 

* For optimal functionality, reliability and precision of your equipment, we recommend maintenance every 2,000 machining hours.



Certified wires

How to choose the best wire for your production needs

Productivity losses amounting to 20 percent can be attributed to not using recommended certified EDM wire. As the world's largest distributor of EDM wire, we offer the right wire for your application needs: precision, speed, surface quality and workpiece complexity. Our wide selection includes high qualitative brass coated wire with special zinc alloy, copper core wires as well as special wires for specific applications needs.

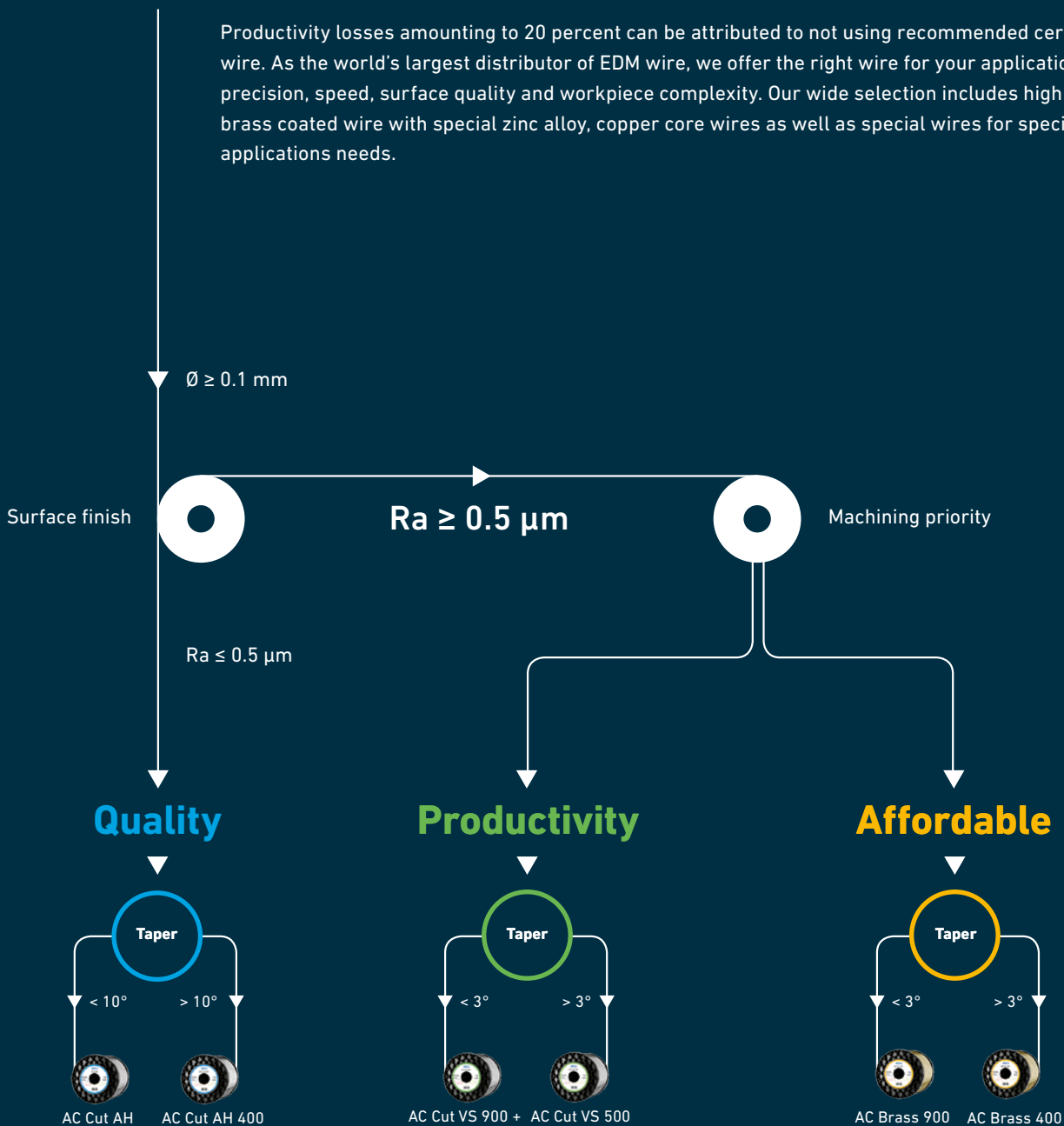

Technical data



CUT E 350



CUT E 350

		CUT E 350	CUT E 600
Machine			
Dimensions of complete equipment *	mm	1750 x 2470 x 2200	2020 x 2790 x 2320
	in	68.9 x 97.24 x 86.61	79.53 x 109.84 x 91.34
Total weight of equipment without dielectric	kg (lbs)	2525 (5567)	4440 (9789)
Work area			
Part dimensions	mm	820 x 680 x 250	1030 x 800 x 350
	in	32.28 x 26.77 x 9.84	40.55 x 31.5 x 13.78
Max. part weight	kg (lbs)	400 (882)	1000 (2205)
Level of dielectric min./max.	mm (in)	0/240 (0/9.45)	0/380 (0/14.96)
Air supply			
Pressure	bar	6-7	6-7
Min. flow	l/min	150 (39.6 gal/min)	150 (39.6 gal/min)
Axes			
X, Y, Z Travel	mm	350 x 250 x 250	600 x 400 x 350
	in	13.78 x 9.84 x 9.84	23.62 x 15.75 x 13.78
U, V Travel	mm (in)	± 45 (± 1.77)	± 50 (± 1.97)
Taper angle/height	°/mm	± 30/77 or ± 25/96	± 30/77 or ± 25/96
	°/in	± 30/3.03 or ± 25/3.78	± 30/3.03 or ± 25/3.78
X, Y, U, V, Z measurement resolution	µm (µ-inch)	0.1 (3.94)	0.1 (3.94)
Speed of axis movement (XYZ)	mm/min (in/min)	0-3000 (0-118.1)	0-3000 (0-118.1)
Anti-collision protection for axes		X, Y, Z	X, Y, Z
Dielectric			
Type		Deionised water	Deionised water
Total volume of dielectric	l	760 (200.77 gal)	1000 (264.17 gal)
Filtering cartridges		2	2
Deionization bottle (not standard)	l	1 (0.26 gal)	1 (0.26 gal)
Deionization resin (not standard)	l	20 (5.3 gal)	20 (5.3 gal)

* Width x depth x height



CUT E 600



CUT E 600

		CUT E 350	CUT E 600
Electrode/Wire			
Standard wire guide	mm in	Ø 0.20 or Ø 0.25 Ø 0.008 or Ø 0.010	Ø 0.20 or Ø 0.25 Ø 0.008 or Ø 0.010
Wire diameter (according to configuration equipment)	mm in	Ø 0.1-0.3 Ø 0.004-0.012	Ø 0.1-0.3 Ø 0.004-0.012
Automatic threading for wires	mm in	Ø 0.1-0.3 Ø 0.004-0.012	Ø 0.1-0.3 Ø 0.004-0.012
Automatic rethreading for wires	mm in	Ø 0.1-0.3 Ø 0.004-0.012	Ø 0.1-0.3 Ø 0.004-0.012
Min. diameter of pre-hole for automatic threading	mm in	Ø 0.2-0.3 Ø 0.008-0.012	Ø 0.2-0.3 Ø 0.008-0.012
Max. height for automatic threading with 0.25 mm wire (0.010 inch)	mm in	220 8.66	220 8.66
Permissible weights and types of reel	kg lbs	5 (JIS P5), 25 (DIN 160) 11.02 (JIS P5), 55.11 (DIN 160)	5 (JIS P5), 25 (DIN 160) 11.02 (JIS P5), 55.11 (DIN 160)
Best Ra Tungsten Carbide/Steel	µm (µ-inch)	0.12/0.18 (4.72/7.09)	0.12/0.18 (4.72/7.09)
Max. machine cutting speed	mm ² /min (in ² /min)	300 (0.46)	300 (0.46)
Cabinet			
Three-phase input voltage	V	380/400	380/400
Network frequency	Hz	50 or 60	50 or 60
Permissible fluctuations		± 10%	± 10%
Total installed power	kVA	10	10
Permissible micro-break	ms	4	4
Power factor		0.8	0.8
Screen/Operating system		TFT 19"/Windows 7	TFT 19"/Windows 7
CD-ROM/Keyboard		No/No	No/No
Ethernet port USB		Yes	Yes
Remote control		Yes	Yes
Ambient conditions			
Temperature for optimum accuracy		20 ± 1°C (68 ± 33.8°F)	20 ± 1°C (68 ± 33.8°F)
Temperature for operation of the equipment		15-30°C (59-86°F)	15-30°C (59-86°F)
Permissible relative humidity		40-80%	40-80%
Max. sound emission of the machine	Db(A)	76	76
Thermal stabilization time	h	3	3
Level of protection of electrical equipment	IP	43	43

CUT E 350

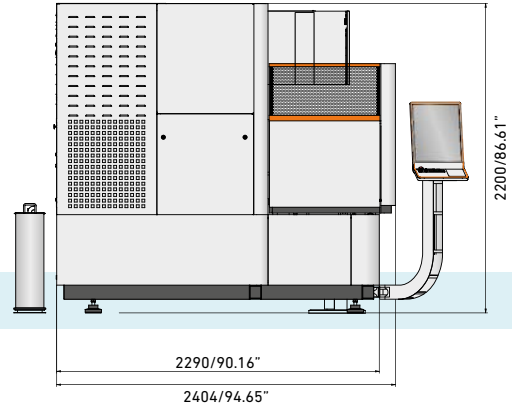
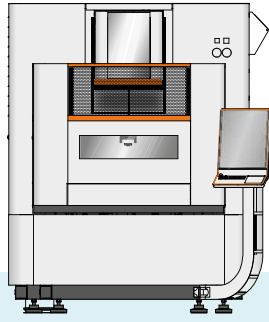

2200/86.61"

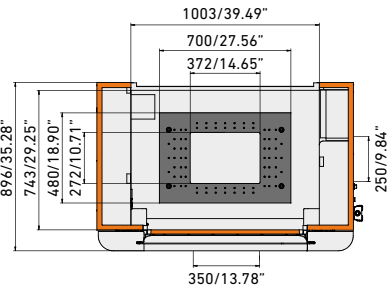
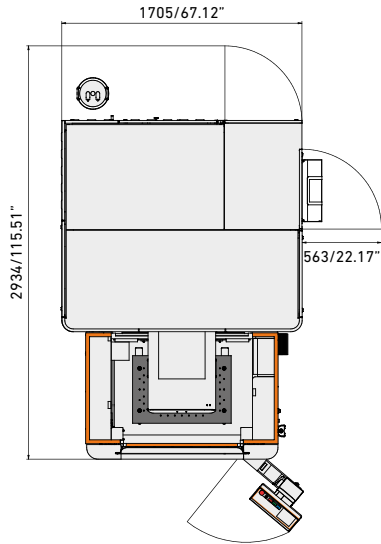

CUT E 600

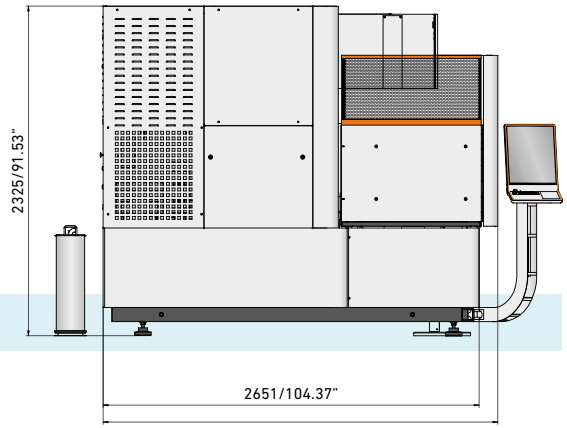
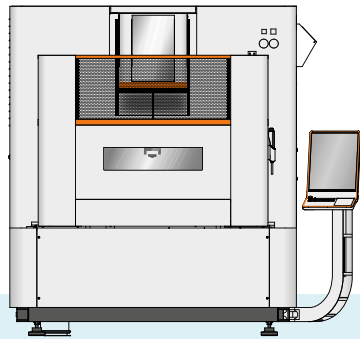

2325/91.53"

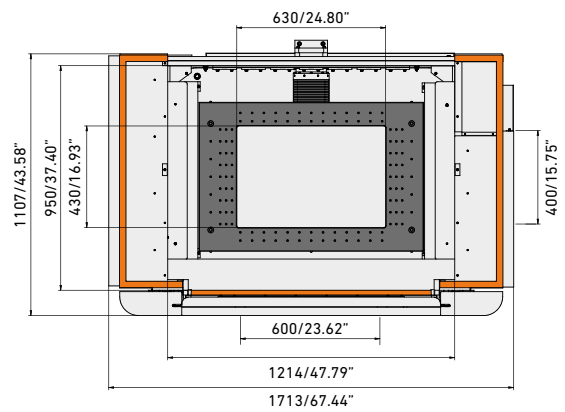
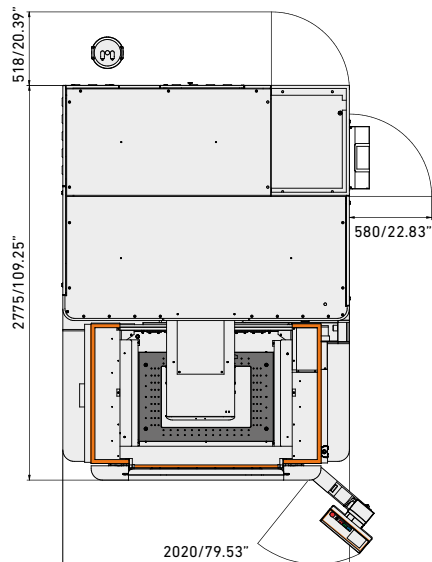

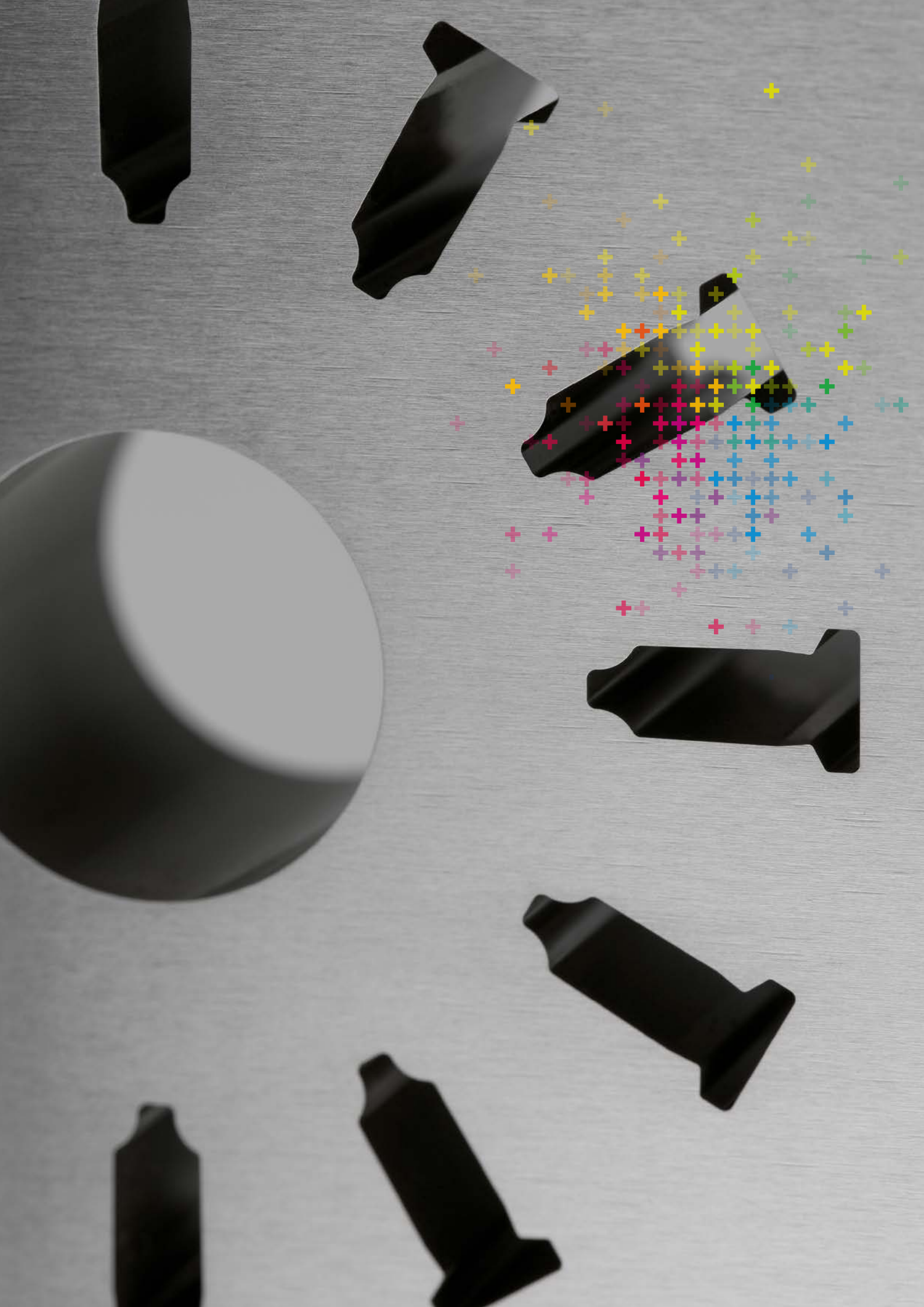

GF Machining Solutions



EDM (electrical discharge machining)

AgieCharmilles wire-cutting, die-sinking and hole-drilling machines

For over 60 years we have been at the forefront of every EDM development: designing and refining the EDM process and building machine tools that deliver peerless part accuracies, surface finishes, cutting speeds and process reliability. Today, our AgieCharmilles wire-cutting, die-sinking and hole-drilling machines are recognized throughout the world as the best in the business. Our continuous research and development in digital generator technology, control systems and integrated Automation systems are evidence of our commitment to keeping your EDM operations on the leading edge of technology.



Laser

AgieCharmilles Laser texturing machines

Laser texturing is a fully-digitized surface engineering process that has huge potential. The technology enables precise 2D and 3D textures or engravings to be machined accurately and directly onto complex parts or molds to improve and alter their aesthetic appeal, functionality and performance. The process is infinitely repeatable and offers many distinct environmental and economic advantages over conventional texturing processes.

Laser Additive Manufacturing (AM)

GF Machining Solutions has partnered with EOS, the global leader for high-end AM solutions, to integrate this innovative technology and further develop it into its current solutions to fully benefit the mold industry, by focusing on injection efficiency: optimized cooling design to reduce cycle time, lower energy consumption, higher quality of plastic parts.



Tooling and Automation

System 3R Tooling, Automation and software

Productivity is the key to manufacturing success, and automating a manufacturing process is a proven method of increasing its efficiency, effectiveness, quality and reliability. System 3R's integrated Tooling, Automation and software solutions ranging from simple workpiece pallet and electrode changers through to flexible manufacturing and robot handling systems are guaranteed to help you increase their competitive advantage.



Milling

Mikron high-speed (HSM), high-performance (HPM) and high-efficiency (HEM) Milling centers

Customers operating in the mold, tool and die and precision component manufacturing sectors stake their reputations on being able to quickly and cost-competitively meet their customers' demands. That's why they invest in GF Mikron machines. Incorporating the latest and most advanced technologies and premium-performance components, Mikron HSM, HPM and HEM machines help you increase your production capabilities and improve your productivity. Designed and built for speed, accuracy and reliability, the machines, like you, are proven performers.

Liechti dedicated aerospace and energy machining centers

Aerospace and power generation turbine manufacturers increasingly turn to Liechti dedicated five- and six-axis machining centers to machine complex, high-precision airfoils on blades, disks, blisks, blisks/IBRs and impellers. It's easy to see why because these machines, with their specific profile machining technology, specialized CAD/CAM software and engineering competence for ultra-dynamic machining in titanium, Inconel, nimonic, titanium-aluminide and high-alloy steels, yield productivity gains as much as 30 percent, thanks to reduced machining times. In the globally competitive aerospace and power generation manufacturing sector, that's definitely worth shouting about.

Step-Tec Spindles

At the heart of every GF Mikron machining center is high-performance Step-Tec Spindle. Step-Tec Spindles are essential core components of our machining centers. Highly accurate and thermally stable Step-Tec Spindles ensure that our machines can handle everything from heavy-duty roughing to fine-finishing operations.



Customer Services

Operations Support, Machine Support and Business Support

To help you get the most and the best from your machine tools and equipment, we offer three levels of support. Operations Support covers our range of original wear parts and certified consumables (EDM wires, filters, resins, electrodes etc.) to ensure that your machines are performing at the highest levels. Machine Support maximizes, through our best-in-class technical support, preventive services and quality spare parts, your machine tool uptime. Business Support is designed to help you make a real step-change in your productivity and performance with solutions tailored to your specific needs.

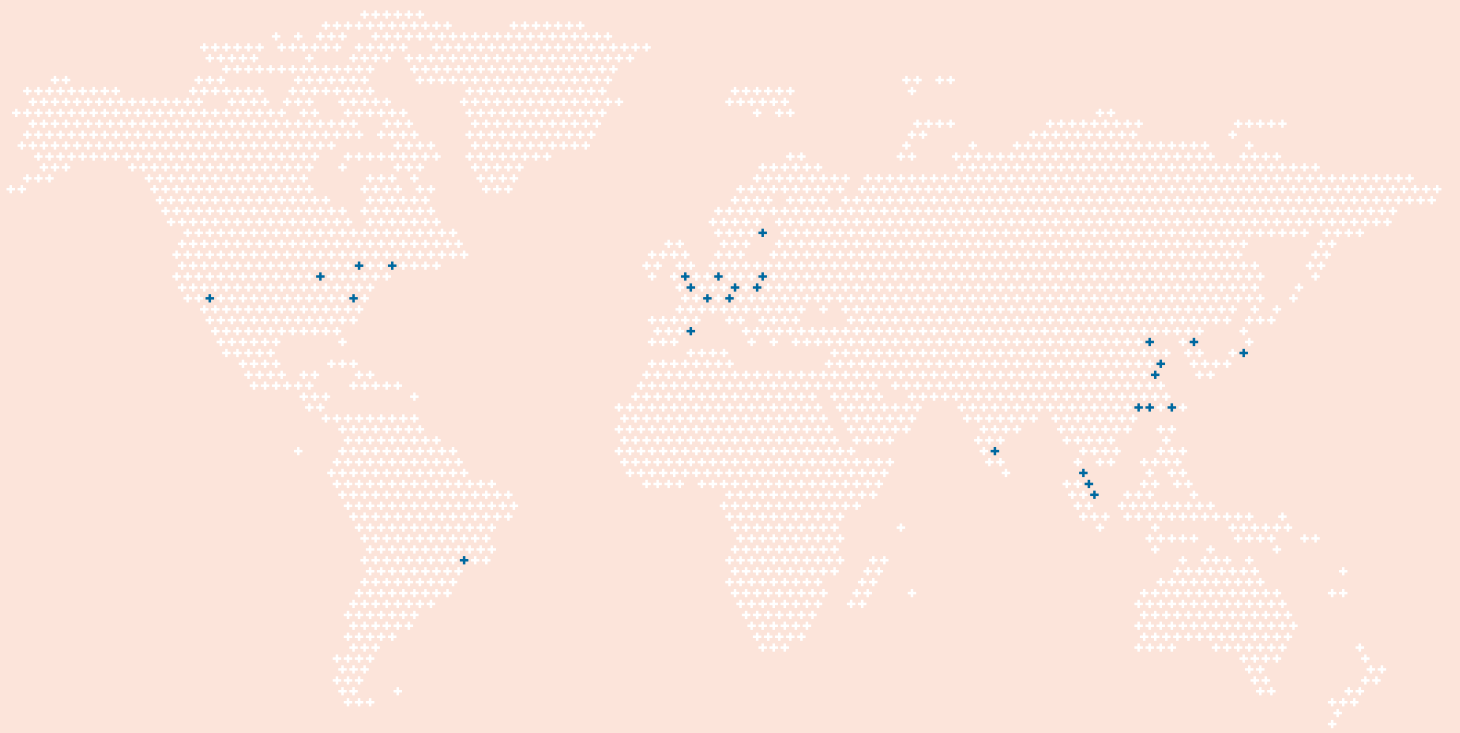

At a glance

We enable our customers to run their businesses efficiently and effectively by offering innovative Milling, EDM, Laser, Additive Manufacturing, Spindle, Tooling and Automation solutions. A comprehensive package of Customer Services completes our proposition.

www.gfms.com

